

plas-aid

The reliable choice in size reduction equipment.

PERFORMANCE

PORTABILITY

RELIABILITY

MGL/SMGL SERIES

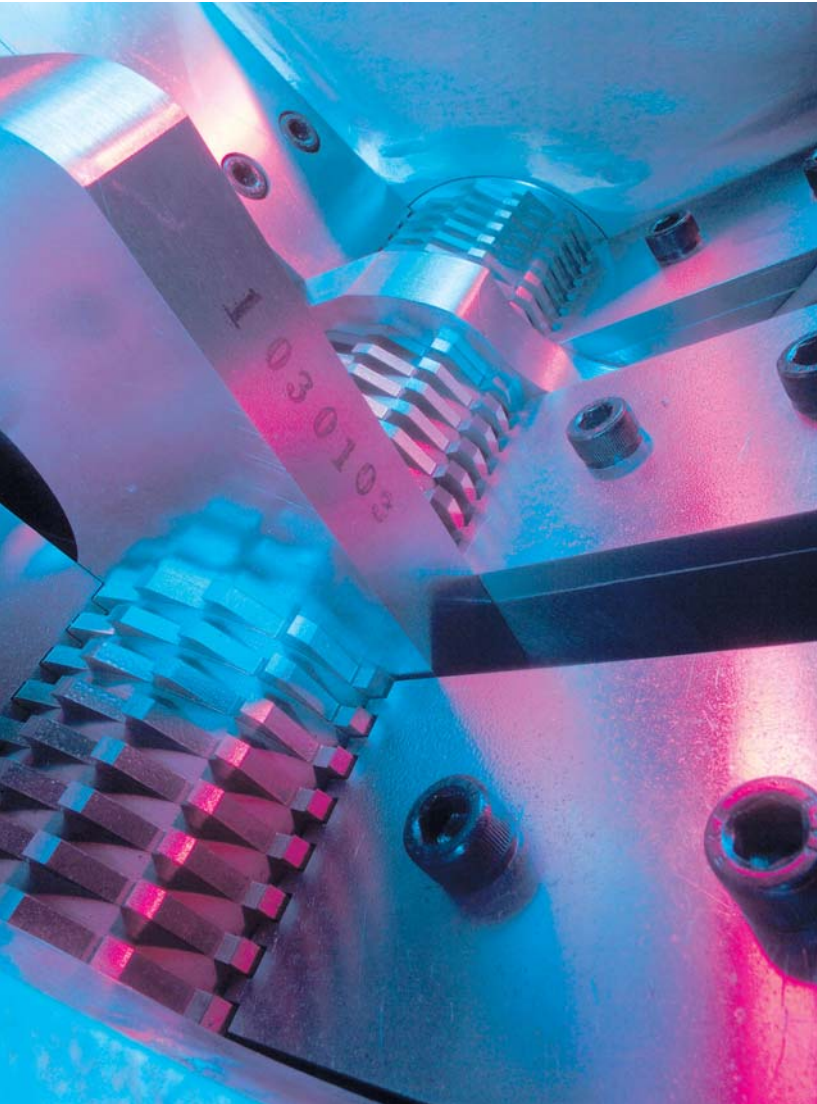

Introducing the **MGL/SMGL**

portable grinders.

Reliable, high performance

in a compact, **portable** design.

Only from Matsui.

MGL/SMGL SERIES

Take a look at what the new MGL & SMGL offer:

SMART DESIGN ENHANCES PRODUCTIVITY

The MGL & SMGL pack a lot of smart engineering into little grinders. Combining low-speed, energy-saving, granulating technology with primary and secondary blades, the MGL & SMGL grind to a consistent size. Dusting and cutting errors are reduced, and no "longs" can slip through. This results in regrind that flows more consistently into your production, moving easily through your material handling systems and molding with fewer rejects.

QUIET, SAFE OPERATION

The SMGL incorporates a steel damper plate to significantly reduce noise, so it operates quietly and efficiently. Units are also equipped with two limit switches and an emergency shut-off button. An integrated thermostat helps prevent the motor from overheating.

SMALL FOOTPRINT AND PORTABLE DESIGN

The SMGL has a tiny footprint, so it easily glides into place, tucking neatly into a convenient, out of the way place, or snugly up against a machine.

EASY-TO-CLEAN AND VIRTUALLY MAINTENANCE FREE

Stainless steel components and easy-clean design make changing material and color a snap. And both units are screenless, so there is even less maintenance and no screen to wear out and replace. The smart, simple design means years of reliable, maintenance-free operation.



Superior grinding technology that enhances productivity.

NOW IN A COMPACT PORTABLE DESIGN.

SMGL grinder is easy to clean, economical to use

Clean up and resin changes are fast and easy. The SMGL opens wide to expose grinding chamber and blades. And stainless steel parts clean up fast and reduce maintenance costs. Low speed cuts energy costs. Various blade sizes are available to help create re-grind that flows smoothly into production.



MGL Grinder with the new "wide-open" design.

Say aaaah! The new MGL lets you spread it "wide-open" for fast, easy cleaning, and product and color changes. The unit "unfolds" to completely, and safely, expose every nook and cranny so you can quickly clean and prepare for the next job without worry of contamination.

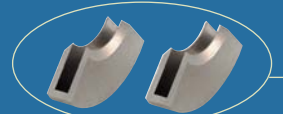

Cutter casings simply lift out for cleaning. No tools needed.

1



2

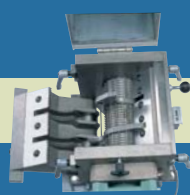

3

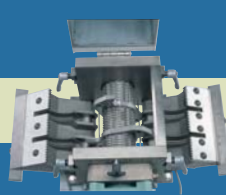

4

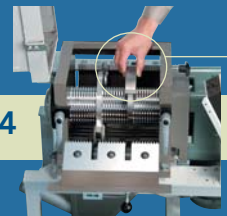

MGL/SMGL SERIES SPECIFICATIONS

MODEL	MGL-20W	MGL-50W	MGL-100	MGL-100-TPE	MGL-200	MGL-300W
POWER (VOLTS)	230 or 460					
MOTOR CAPACITY (HP)	0.25	0.5	1.0	1.0	2.0	3.0
ROTATING SPEED (RPM)	30		22.5			30
SMALL ROTATING CUTTERS	2		3			
LARGE ROTATING CUTTERS	1		2			
BED CUTTER	1		3			
CRUSHING BED CUTTER			1			
GUIDE PLATE	2		3	1		3
SIZE OF RUNNER CHUTE (INCHES)	5.2x5.3	7.8x7.5	13.0x9.0	13.0x9.0	14.9x13.0	18.7x16.5
EFFECTIVE CHAMBER DIM (INCHES)	4.8x5.3	7.4x7.5	10.0x9.0	10.0x9.0	12.6x12.6	15.7x16.5
MACHINE DIMENSIONS (INCHES)	17x13.5x35.5	21x14x55	29x16x57	29x16x57	34x22x63	43x23x62
CUTTER SIZE (MM)	4 x 4	4 x 5	5x5	5x5	5x6	6x7
WEIGHT (LBS)	117	180	375	374	528	814
FULL LOAD 230/460V (AMPS)	3.0/1.5	5.0/2.5	10.0/5.0	10.0/5.0	15.0/7.5	20/10
SUCTION HOPPER (FT ³)	0.07	0.14	0.15	0.49	0.28	0.45
PROCESSING CAPACITY (LBS/HR)	4.4	6.6	11.0	6.6	22	33
MAX. RUNNER DIMS W/D/H (INCHES)	3.5x2.4x2.0	6.0x3.5x2.4	8.7x6.0x 4.0	8.7x6.0x4.0	10.6x7.5x4.7	13.8x9.8x6.0
MAX. RUNNER DIAMETER (INCHES)	0.12	0.15	0.28	0.28	0.35	0.40

MODEL	SMGL-100	SMGL-200	SMGL-300
POWER (VOLTS)	230 or 460		
MOTOR CAPACITY (HP)	1.0	2.0	3.0
ROTATING SPEED (RPM)	22.5		
SMALL ROTATING CUTTERS	3		
LARGE ROTATING CUTTERS	2		
BED CUTTER	3		
GUIDE PLATE	1	3	
SIZE OF RUNNER CHUTE (INCHES)	13.3x9.2	14.9x13.0	23.9x21.0
EFFECTIVE CHAMBER DIM (INCHES)	10.4x10.2	13.8x11.4	16.0x16.0
MACHINE DIMENSIONS (INCHES)	30x17x57	36x22x63	48x23x68
CUTTER SIZE (MM)	4 x 5	5 x 5	6x7
WEIGHT (LBS)	396	605	990
FULL LOAD 230/460V (AMPS)	10.0/5.0	15.0/7.5	20/10
SUCTION HOPPER (FT ³)	0.15	0.28	0.42
PROCESSING CAPACITY (LBS/HR)	11	13	33
MAX. RUNNER DIMS W/D/H (INCHES)	8.7x6.0x4.0	10.7x7.5x4.7	13.8x9.8x6.0
MAX. RUNNER DIAMETER (INCHES)	0.28	0.28	0.40

RUNNER DIMENSIONS AND DIAMETER

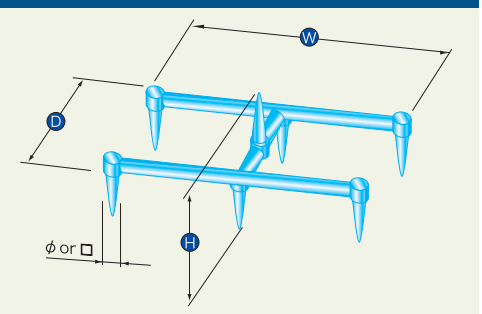

REGRIND RATIO VALVE	JSV-38	JSV-50
PORT SIZE	1.5"Ø	2.0"Ø
REQUIRED AIR PRESSURE	50-70 psi	50-70 psi
DIMENSIONS (INCHES)	9.9x8.7x13.2	9.9x8.7x13.2



JSV VALVE APPLICATION

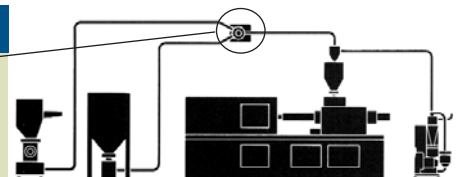

Matsui America
www.matsuiamerica.com

CHICAGO HEADQUARTERS

1250 West Lunt Avenue | Elk Grove Village, IL 60007 | T 847-290-9680 | F 847-290-9685

LOS ANGELES OFFICE

1240 North Lakeview, Suite 180 | Anaheim, CA 92807 | T 714-693-1101 | F 714-693-1345